



苏州群力欣光电科技有限公司

Suzhou Que-lesion Optoelectronic Technology co.,Ltd

产品规格书

SPECIFICATION

客户名称 Customer		产品名称 Product	3528LED
客户料号 Customer No.		产品型号 Type	QSTR8B4-14-20MA
规格书编号 SPEC No	20190225001	日期 Date	2019.02.25

客 户 确 认 APPROVED SIGNATURES		

制定(DRAW) 梁荣 审核(CHECK): 王业军 批准 (APPROVE): 邱利强

地址:江苏省苏州市相城区阳澄湖镇石田路 3 号

ADD:NO.3 shitian road,yangchenhu town,xiangcheng district,Suzhou,china

电话(Tel): 0512-69599058

传真(Fax):0512-65485461



QSTR8B4-14-20MA

特征 Features

- 宽的发光角度
Extremely wide viewing angle
- 适合所有 SMT 组装和焊接过程
Suitable for all SMT assembly and solder process
- 可用在载带及卷轴上
Available on tape and reel
- 防潮等级:2 级
Moisture sensitivity level: Level 2
- 包装:2000pcs/卷
Package:2000pcs/reel
- 符合欧盟 RoHS 标准
RoHS compliant

描述 Description

该产品 LED 由蓝光芯片与荧光粉激发而成

The White LED which was fabricated using a blue chip and the phosphor

应用 (Applications)

光学指示

Optical indicator

室内显示

Indoor display

汽车照明

Automotive lighting

LCD 背光、转换器，开关和标志，显示器等 Backlight for LCD , switch and symbol , display

用于日光灯管

Tubular light application

一般应用

General use

QSTR8B4-14-20MA

外形尺寸 Outline Dimensions

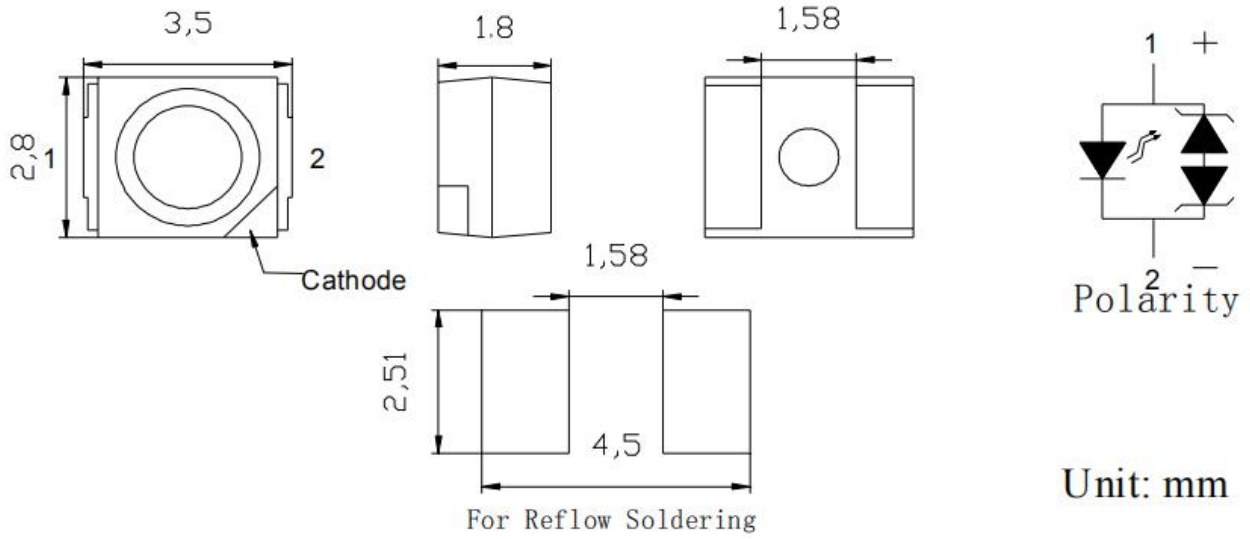

Unit: mm



QSTR8B4-14-20MA

Dice Material	Light Color	Lens Color
InGaN	White	Color Diffused

Item	Symbol	Maximum	Unit
Power dissipation	PD	87.5	mW
Continuous forward current	IFmax	25	mA
Peak forward current (1/10 duty cycle 0.1ms pulse width)	IFP	100	mA
Reverse voltage	VR	5	V
Electrostatic Discharge (HBM)	ESD	2000	V
Operating temperature range	Topr	-30 to +85	°C
Storage temperature range	Tstg	-40 to +100	°C

Item	Symbol	Condition	Min	Typ	Max	Unit
Forward voltage	VF	IF=20mA	-	2.9	3.5	V
CIE	X、Y	IF=20mA	-	X=0.34	-	
			-	Y=0.34	-	
Viewing Angle	2θ _{1/2}	IF=20mA	-	120	-	Deg
Luminous Intensity	Iv	IF=20mA	-	2500	-	mcd
Reverse Current	Ir	Vr=5V			10	uA

※ The measuring tolerance → Luminous intensity ±15%

X、Y ± 0.01



QSTR8B4-14-20MA

Optical/Electrical Characterization

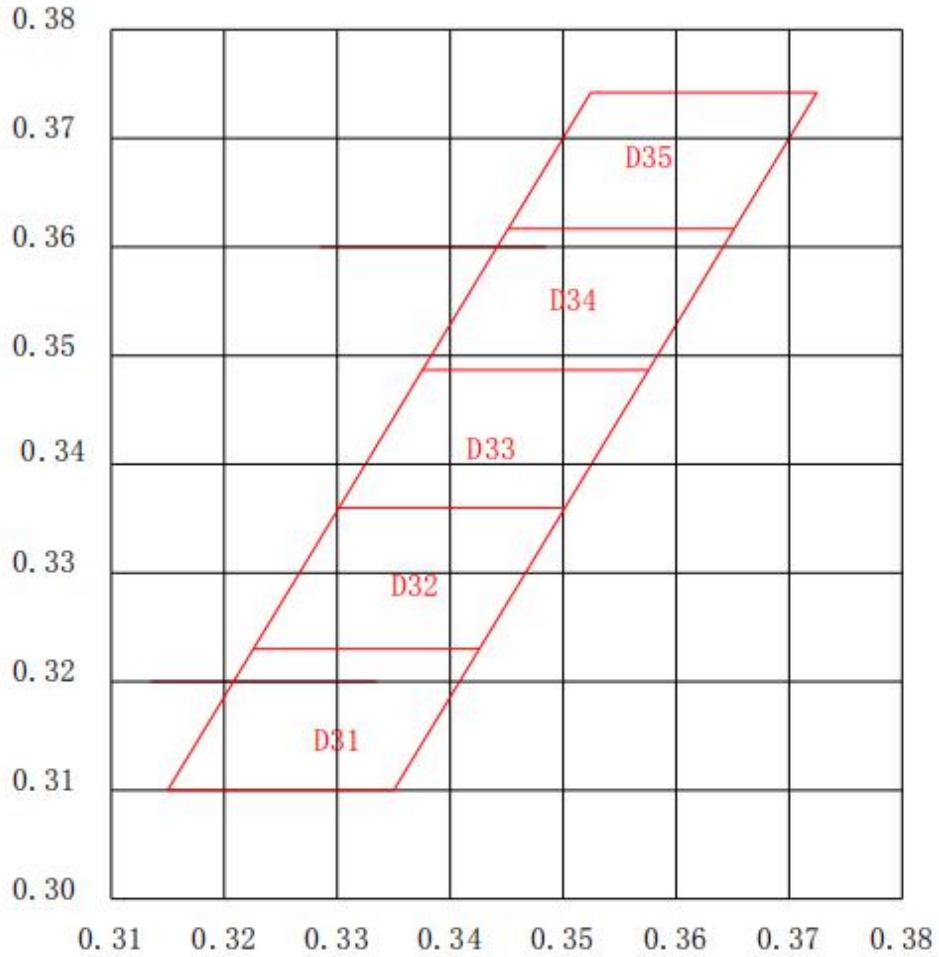



QSTR8B4-14-20MA

Test Condition @20mA		
BIN Code	IVmin(mcd)	IVmax (mcd)
J	1800	2000
K	2000	2200
L	2200	2400
M	2400	2600
N	2600	2800
P	2800	3000
Q	3000	3200

Test Condition: @20mA								
Bin Cod	X1	Y1	X2	Y2	X3	Y3	X4	Y4
D31	0.3150	0.3100	0.3350	0.3100	0.3426	0.3230	0.3226	0.3230
D32	0.3226	0.3230	0.3426	0.3230	0.3502	0.3360	0.3302	0.3360
D33	0.3302	0.3360	0.3502	0.3360	0.3576	0.3487	0.3376	0.3487
D34	0.3376	0.3487	0.3576	0.3487	0.3651	0.3617	0.3451	0.3617
D35	0.3451	0.3617	0.3651	0.3617	0.3725	0.3742	0.32525	0.3742

Test Condition: @20mA					
BIN Code	Vfmin(v)	Vfmax(v)	BIN Code	Vfmin(v)	Vfmax(v)
E	2.8	2.9	H	3.1	3.2
F	2.9	3.0	I	3.2	3.3
G	3.0	3.1	J	3.3	3.4

QSTR8B4-14-20MA

Forward Current Vs. Forward Voltage

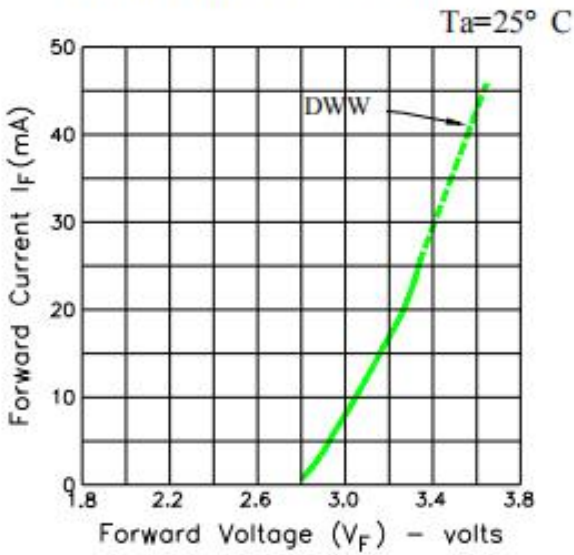

Luminous Intensity Vs. Forward Current

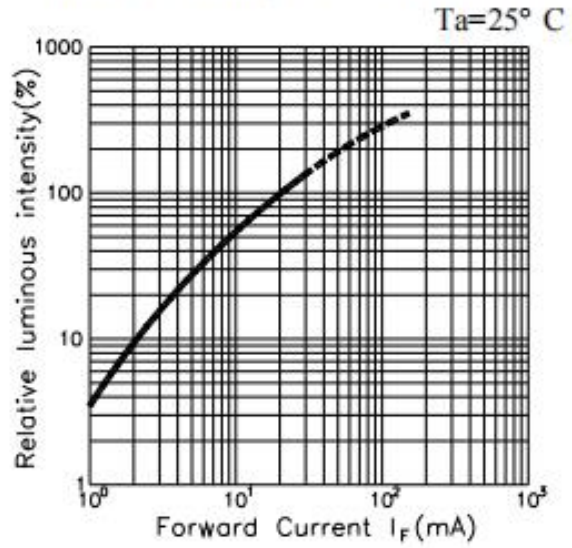

Forward Current Derating Curve

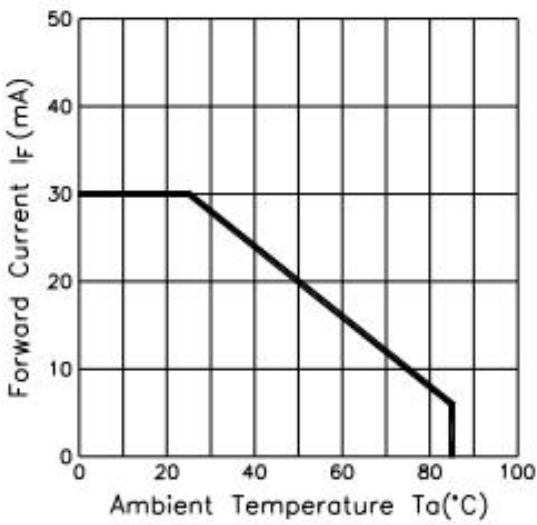

Radiation Diagram

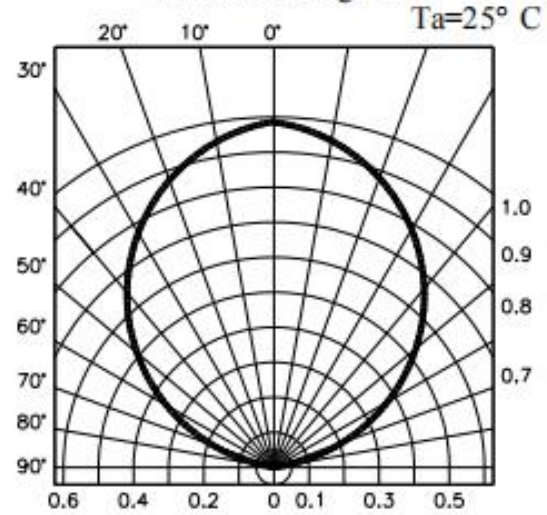

Spectrum Distribution

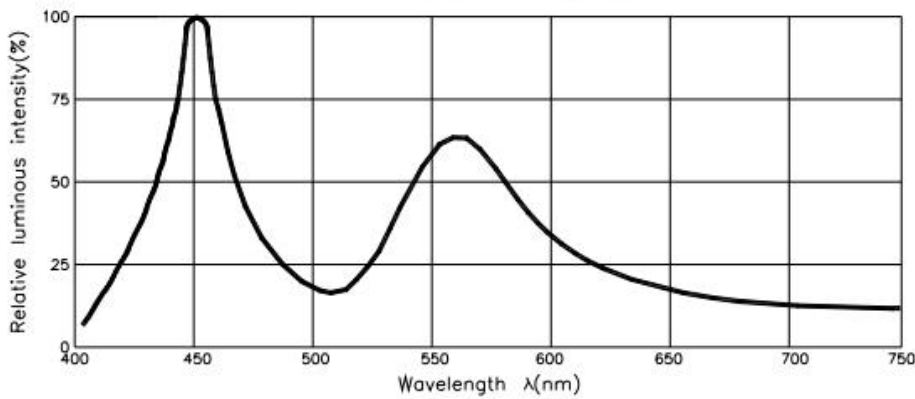

QSTR8B4-14-20MA

Reliability Test Items And Conditions :

No.	Item	Test Conditions	Test hr/cycle/time	Sample Q'ty	Ac / Re
1	Solder Heat	TEMP: 260°C±5°C ; 10±1 sec	2 times	30 pcs	0 / 1
2	Solder ability Test ※	TEMP : 235°C±5°C ; 3±1 sec	1 time	5 pcs	0 / 1
3	Temperature Cycle	H : +85°C 30min. ∫ 5min. L : -40°C 30min.	100 cycles	20 pcs	0 / 1
4	Thermal Shock	H : +85°C 5min. ∫ L : -40°C 5min.	50 cycles	20 pcs	0 / 1
5	High Temperature Storage	TEMP : 85°C	1000 hrs	20 pcs	0 / 1
6	Low Temperature Storage	TEMP : -40°C	1000 hrs	20 pcs	0 / 1
7	DC Operating Life	I _F = I _{Fmax}	1000 hrs	20 pcs	0 / 1
8	High Temperature High Humidity	85°C / 90~95%R.H.	1000 hrs	20 pcs	0 / 1
9	Shocking test	100~2000Hz ; 98.1m/s ² X,Y,Z direction	2 hrs	20 pcs	0 / 1
10	Dropping test	Put on pallet ; height : 75cm	3 times	20 pcs	0 / 1
Judgment Criteria					
Forward Voltage V _F		V _F Max-Increase < 1.1x			
Reverse Current I _R		I _R Max-Increase < I _{Rmax}			
Luminous Intensity I _V		I _V Decay < 40%			
※Solder ability test criteria : coverage is not less than 95%					
Note : Measurement shall be taken after the tested samples have been returned to normal ambient conditions (generally after two hours)					

Test Circuit

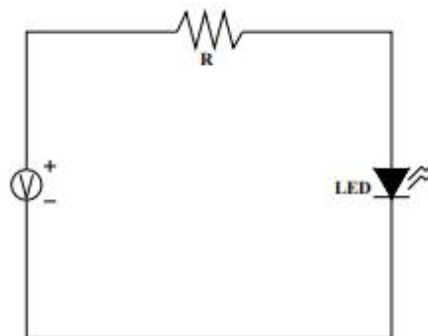

QSTR8B4-14-20MA

包装 Packaging 标签 Label

料号 Part No.:*** 批号 Lot No.:*** 数量 Qty(pcs):***
 亮度 Iv(mcd):*** 波长 (nm) :*** 电压 VF (v) :***
 日期 Date:***

载带规格 (单位: mm) Tape Specifications(Units:mm)

Packing Size													
Item	W	P1	E	F	D0	D1	P0	10P0	P2	A0	B0	K0	T
Spec	8.00	4.00	1.75	3.50	1.50	1.00	4.00	40.00	2.00	3.10	3.80	2.20	0.25
Tolerance	±0.20	±0.10	±0.10	±0.05	+0.10 -0.00	±0.05	±0.05	±0.20	±0.05	±0.10	±0.10	±0.10	±0.05

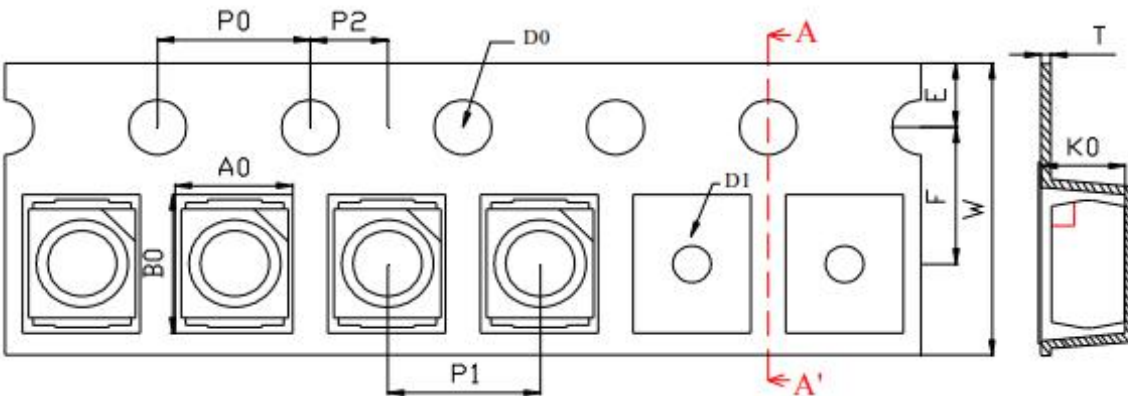

卷轴尺寸 Reel Dimensions

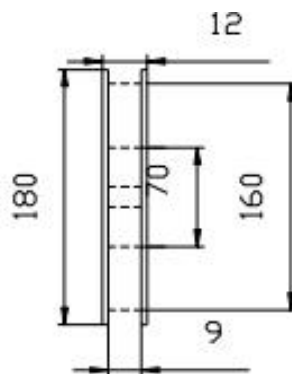

Unit: mm

Unit: mm

QSTR8B4-14-20MA

焊接指导 Guideline for Soldering

Soldering iron 烙铁焊接

1. When hand soldering, keep the temperature of iron below less 300°C less than 3 seconds

当手工焊接时，烙铁的温度必须小于300°C，时间不可超过3秒

2. The hand solder should be done only one times

手工焊接只可焊接一次

Repairing 修补

Repair should not be done after the LEDs have been soldered. When repairing is unavoidable, a double-head soldering iron should be used (as below figure). It should be confirmed in advance whether the characteristics of LEDs will or will not be damaged by repairing.

LED回流焊后不应该修复，当修复是不可避免时，必须使用双头烙铁（如下图），但必须事先确认此种方式会或不会损坏LED本身的特性。

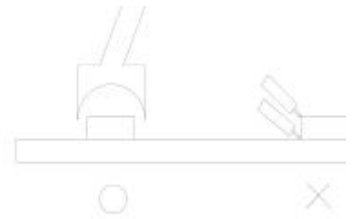
**Cautions 注意事项**

The encapsulated material of the LEDs is silicone. Therefore the LEDs have a soft surface on the top of package. The pressure to the top surface will be influence to the reliability of the LEDs. Precautions should be taken to avoid the strong pressure on the encapsulated part. So when use the picking up nozzle, the pressure on the silicone resin should be proper.

LED封装为硅胶，故LED胶体表面较软，用力按压胶体表面会影响LED可靠性，因此应有预防措施避免在封装的零件上的强大压力，当使用吸嘴时，胶体表面的压力应是恰当的。

3. Do not stack together assembled PCBs containing LEDs. Impact may scratch the silicone lens or damage the internal circuitry

不可将模组材料堆积在一起，它可能会损坏内部电路

4. Not suitable to operate in acidic environment, PH<7

不可用在PH<7的酸性场所

