



苏州群力欣光电科技有限公司

Suzhou Que-lesion Optoelectronic Technology co.,Ltd

产品规格书

SPECIFICATION

产品名称 Product Name	QC2D1G23K23V12B				
产品料号 Product Number		规格书编号 SPEC NO.	20170514001	日期 Date	2017.05.14
客户料号 Customer Number		客户名称 Customer Name			
客户确认 Chuck By		客户核准并 签章 Authorized By		客户产品要 求范围 Application Range	

制定(DRAW): _____ 审核(CHECK): _____ 批准 (APPROVE) :

地址:江苏省苏州市相城区阳澄湖镇石田路 3 号

ADD:NO.3 shitian road,yangchenhu town,xiangcheng district,Suzhou,china

电话(Tel): 0512-69599058

传真(Fax):0512-65485461



特征 Features

- ❖ 宽的发光角度
Extremely wide viewing angle
- ❖ 适合所有 SMT 组装和焊接过程
Suitable for all SMT assembly and solder process
- ❖ 可用在载带及卷轴上
Available on tape and reel
- ❖ 防潮等级:3 级
Moisture sensitivity level: Level 3
- ❖ 包装:4000pcs/卷
Package:4000pcs/reel
- ❖ 符合欧盟 RoHS 标准
RoHS compliant

描述 Description

该产品为白光 LED，是由蓝光芯片激发荧光粉而成

The White LED which was fabricated using a blue chip and the phosphor

应用 (Applications)

- ❖ 光学指示
Optical indicator
- ❖ 室内显示
Indoor display
- ❖ 汽车照明
Automotive lighting
- ❖ LCD 背光、转换器，开关和标志，显示器等
Backlight for LCD , switch and symbol , display
- ❖ 用于日光灯管
Tubular light application
- ❖ 一般应用
General use

❖ 外观尺寸 Appearance size

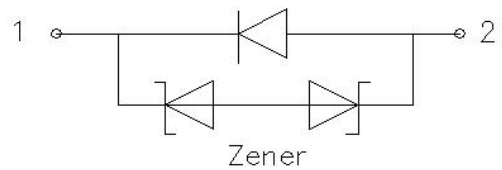
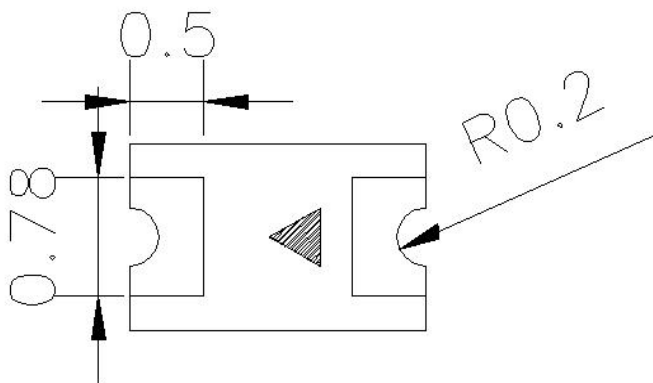
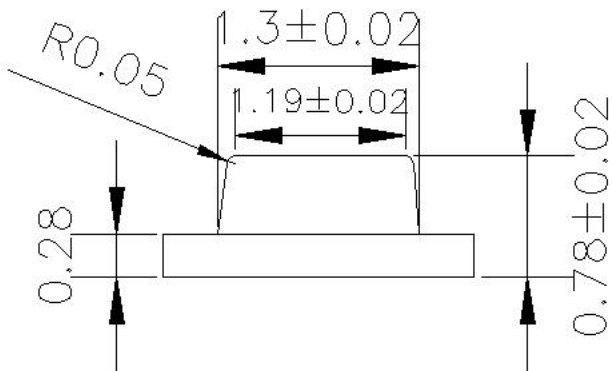
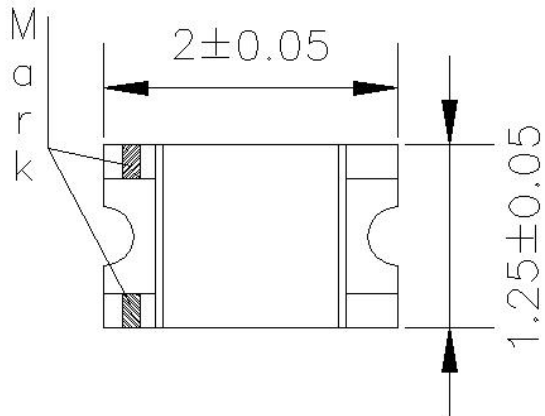

❖ NOTES:

All dimensions units are millimeters.(所有尺寸标注单位为毫米)



光电参数 Electro-Optical Characteristics

❖ 极限参数 (温度=25℃) Absolute Maximum Ratings(Temperaure=25℃)

参数 Parameter	符号 Symbol	数值 Rating	单位 Unit
功耗 Power Dissipation	Pd	90	mW
正向电流 Forward Current	IF	30	mA
峰值正向电流 Peak Forward Current	IFP	100	mA
反向电压 Reverse Voltage	VR	5	V
工作温度 Operating Temperature	Topr	-30~+85	℃
储存温度 Storage Temperature	Tstg	-40~+100	℃

❖ 光电参数 (温度=25℃) Electro-Optical Characteristics (Temperaure=25℃)

参数名称 Parameter	符号 Symbol	条件 Condition	最小值 Min	典型值 Typ	最大值 Max	单位 Unit
反向电流 Reverse Current	IR	VR=5V			10	μA
正向电压 Forward Voltage	VF	IF=5mA	2.4		3.4	V
色度坐标 Chromaticity Coordinates	X			0.3040		
	Y			0.3155		
光强 Luminous Intensity	IV		80		400	mcd
角度 View Angle	2θ _{1/2}			140		deg



❖ 参数范围 Parameter norm

1.) 正向电压 Forward Voltage Bins (IF=5mA)

VF(v)		
Bin Code	Min	Max
A15	2.40	2.60
A16	2.60	2.80
A17	2.80	3.00
A18	3.00	3.20
A19	3.20	3.40

2.) 光强 Luminous Intensity Bins (IF=5mA)

Iv(mcd)		
Bin Code	Min	Max
D17	80	100
D18	100	120
D19	120	150
D20	150	200
D21	200	250
D22	250	300
D23	300	350
D24	350	400

❖ 色坐标 Color Coordinate Comparison

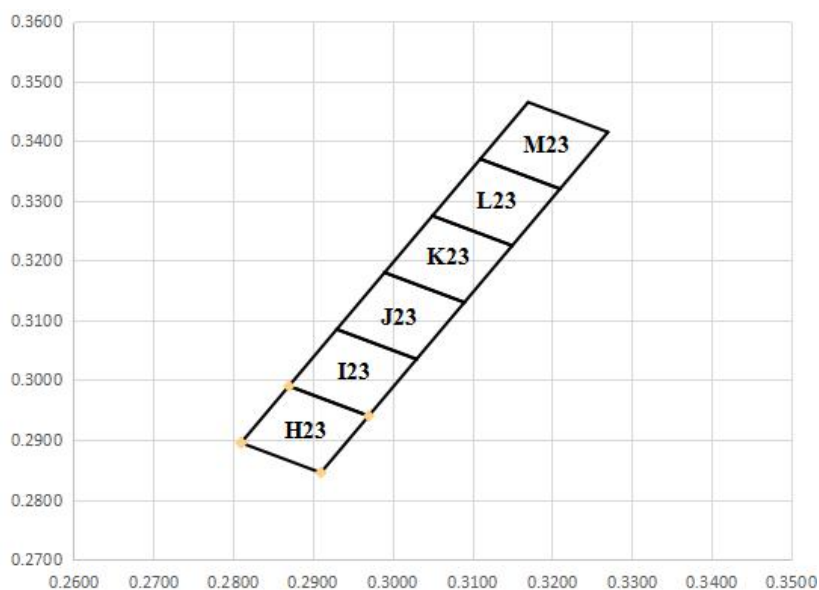

BIN Code											
H23		I23		J23		K23		L23		M23	
CIE-X	CIE-Y	CIE-X	CIE-Y	CIE-X	CIE-Y	CIE-X	CIE-Y	CIE-X	CIE-Y	CIE-X	CIE-Y
0.2810	0.2895	0.2870	0.2990	0.2930	0.3085	0.2990	0.3180	0.305	0.328	0.311	0.337
0.2870	0.2990	0.2930	0.3085	0.2990	0.3180	0.3050	0.3275	0.311	0.337	0.317	0.347
0.2970	0.2940	0.3030	0.3035	0.3090	0.3130	0.3150	0.3225	0.321	0.332	0.327	0.342
0.2910	0.2845	0.2970	0.2940	0.3030	0.3035	0.3090	0.3130	0.315	0.323	0.321	0.332



❖ 光学特性 Electronic-optical Characteristics

1).Relative Spectral Distribution

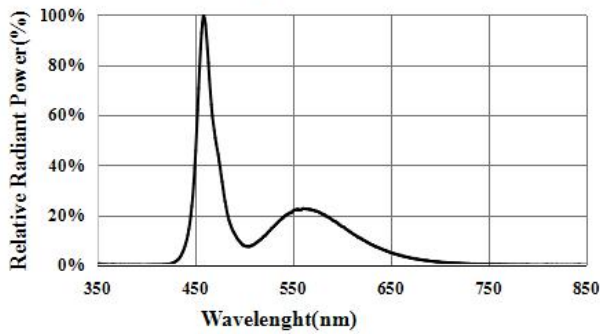

2).Relative Luminous Intensity.Ambient Temperature

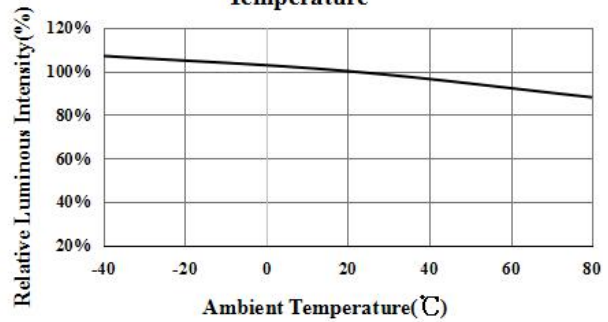

3).Relative Luminous Intensity.Current

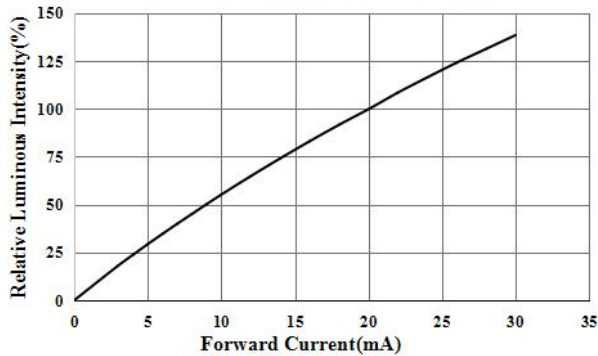

4.)Typical Spatial Distribution

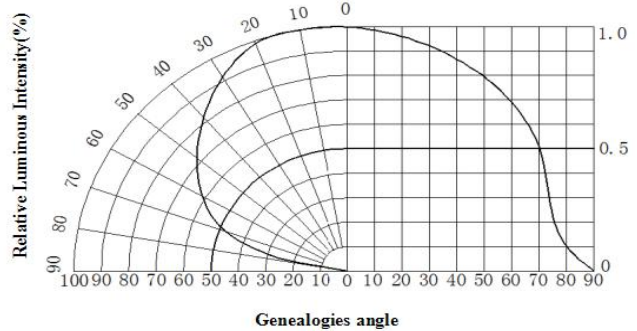

5).Electrical Characteristics

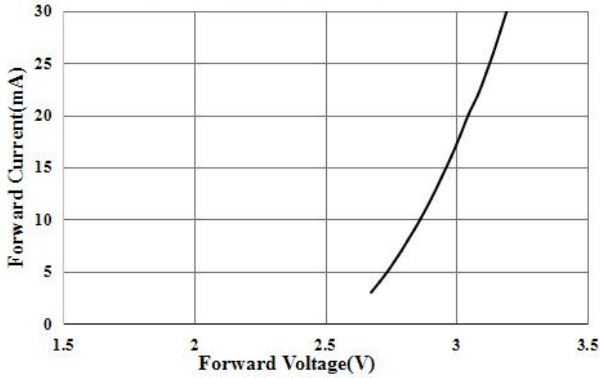

6).Thermal Design

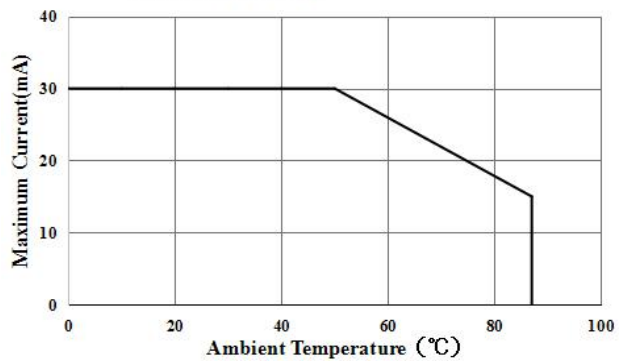

7).Forward Voltage Temperature

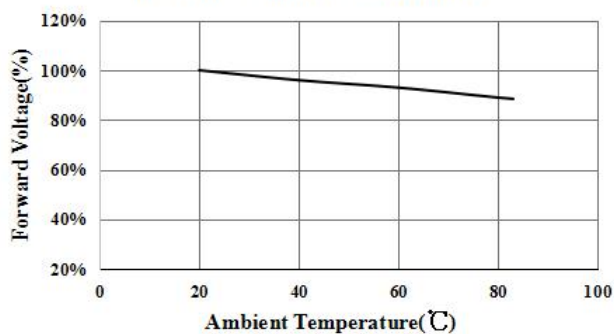

8).Light effect VS Current

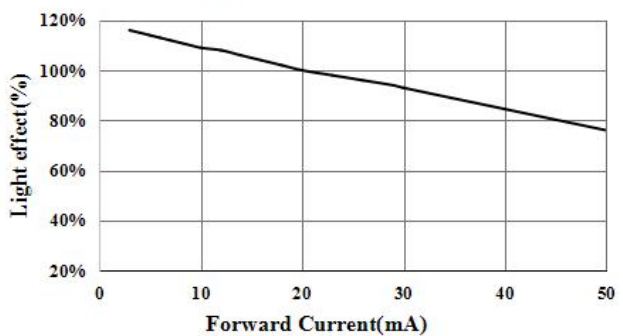



❖ 测试项目和可靠性的结果 Test Items and Results of Reliability

试验项目 Test Items	试验条件 Test Conditions	时间 Time	试验数量 Quantity	接收/拒收 Acceptrd/Rejected
回流焊 Reflow	Temp: 260°Cmax T=10sec	2times	22Pcs	0/1
温度循环 Temperature Cycle	100°C/30min ↓↑ - 40°C/30min	100cycles	22Pcs	0/1
冷热冲击 Thermal Shock	- 40°C/15min ↓↑ 100°C/15min	300cycles	22Pcs	0/1
高温保存 High Temperature Storage	Temp: 100°C	1000Hrs.	22Pcs	0/1
低温保存 Low Temperature Storage	Temp: - 40°C	1000Hrs.	22Pcs	0/1
常温通电 Life Test	Ta=25°C IF=20mA	1000Hrs.	22Pcs	0/1

项目 Test Items	符号 Symbol	测试条件 Test Condition	判定标准 Judging For Damage	
			最小 Min.	最大 Max.
正向电压 Forward Voltage	VF	IF=20mA	-	L.S.L*)x1.1
漏电流 Reverse Current	Ir	Vr=5V	-	L.S.L*)x2.0
光通量 Luminous Flux	lm	IF=20mA	L.S.L*)x0.7	-

备注 Note:

Tsol-锡液温度; IFT:典型电流 Tsol –Temperature of tin liquid ; IFT :Typical current

❖ 包装 Packaging

标签 Label

料号 Part No.:*** 批号 Lot No.:*** 数量 O'ty(pcs):***

亮度 Iv(mcd):*** 坐标 (xy) : *** 电压 VF (v) :***

日期 Date:***

◆ Packing

• Feeding Direction (Unit: mm)

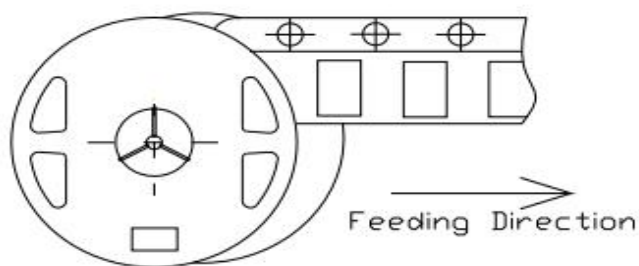

• Dimensions of Reel (Unit: mm)

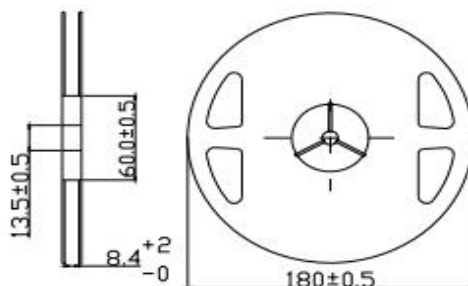

• Dimensions of Tape (Unit: mm)

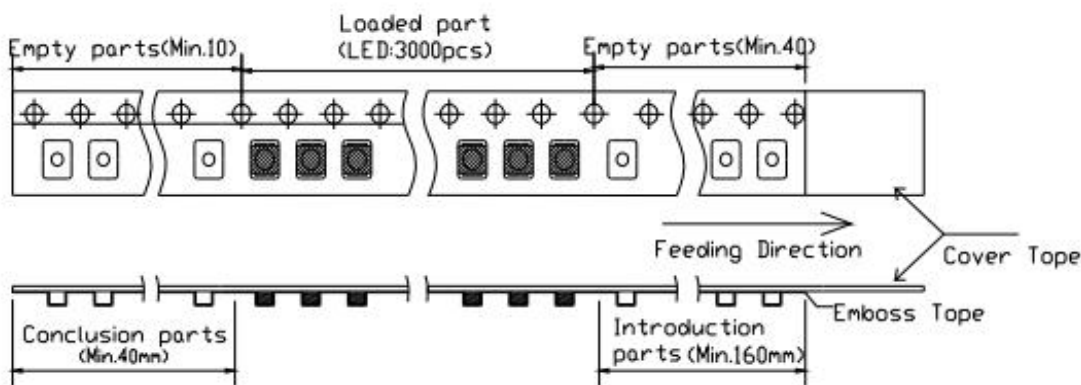
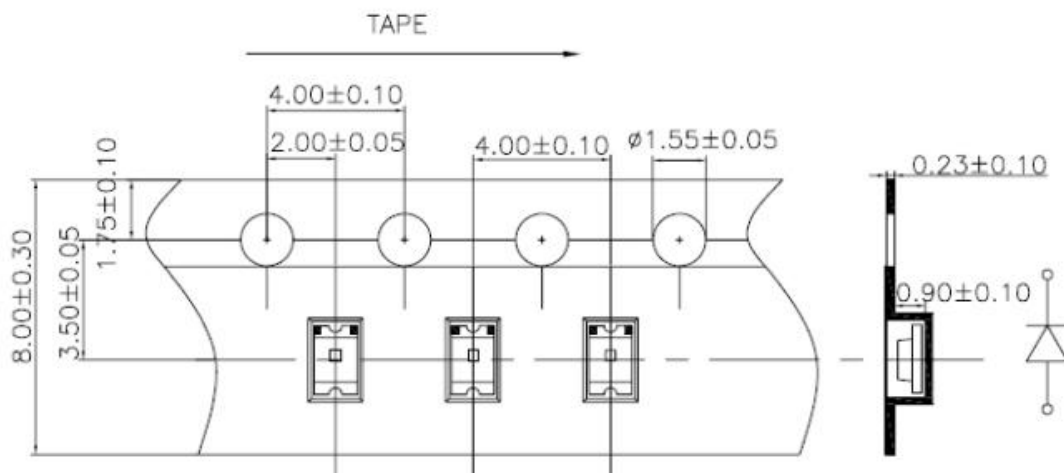

备注：标注公差为±0.1mm,单位：mm

Note : The tolerances unless mentioned is ±0.1mm,Unit:mm

❖ SMT 回流焊说明 SMT reflow soldering instructions

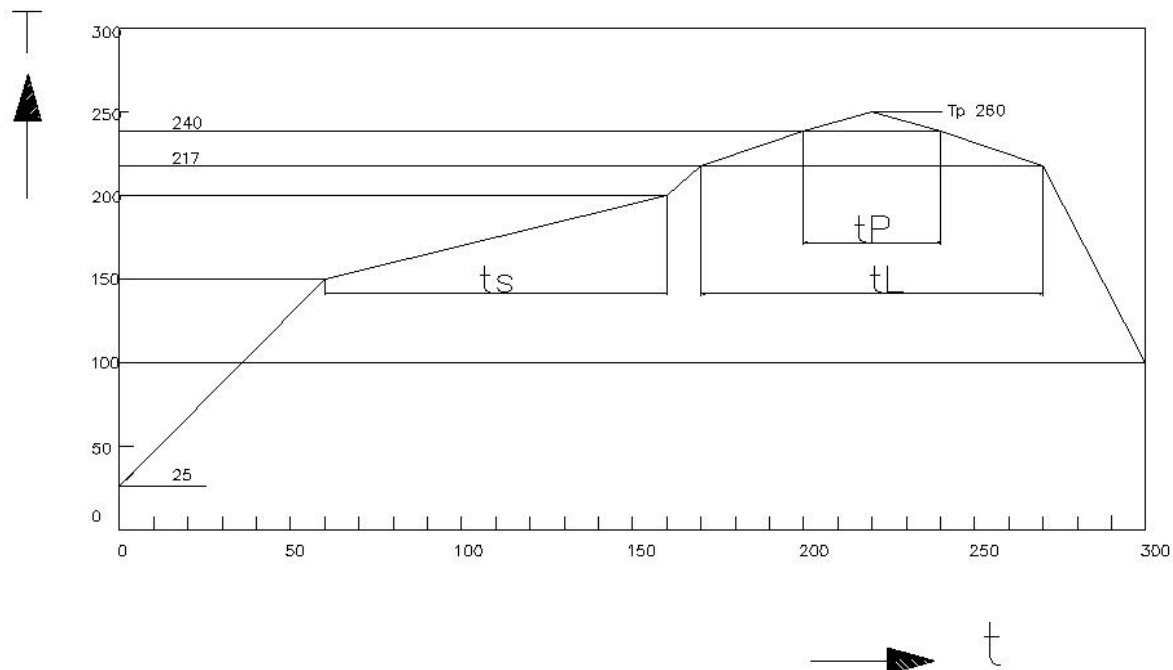

Profile Feature	Symbol 符号	Pb-Free(SnAgCu)Assembly 无铅锡膏			Unit 单位
		Min	Tpy	Max	
Ramp-up rate to preheat(25°C to 150°C) 平均升温速度 (T _{smax} 至 T _p)			2	3	°C/s
Time ts(T _{smin} to T _{smax}) 预热: 时间 (T _{smin} 至 T _{smax})	ts	60	100	120	s
Ramp-up rate to peak(T _{smax} to T _p) T _{smax} 升至峰值温度的速度			2		°C/s
Liquidus temperature 限时维持高温: 温度 (TL)	TL	217	°C		°C
Time above liquidus temperature 限时维持高温: 时间 (tL)	tL				s
Peak temperature 峰值/分类温度 (T _p)	T _p				°C/s
Time within 5°C of the specified peak temperature Tp-5°C 与实际峰值温度 (tp) 相差 5°C 以内的保持时间	tp	10	20	30	s
Ramp-down rate(T _p to 100°C) 降温速度			3	6	°C/s
Time (25°C to T _p) 降温时间				480	s

1.回流焊次数不可超过两次，两次回流焊的时间间隔如果超过 24 小时，LED 可能由于吸湿而损坏。The number of reflow soldering should not exceed two times. If the time interval between two reflow soldering exceeds 24 hours, the LED may be damaged due to moisture absorption.

2.当焊接时，不要在材料受热时用力压胶体表面。When welding, do not press the surface of the gel when the material is heated.

烙铁焊接 Soldering iron

1.当手工焊接时，烙铁的温度必须小于 300℃，时间不可超过 3 秒；When hand soldering, keep the temperature of iron below less 300℃ less than 3 seconds;

2.手工焊接只可焊接一次；The hand solder should be done only one times;

推荐焊盘 Recommended welding plate(Unit:mm)

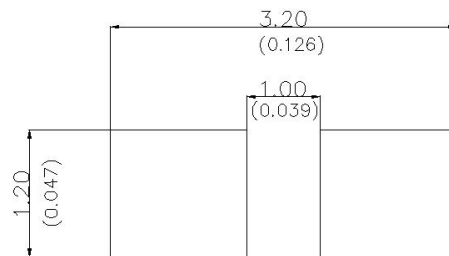

修补 Repairing

LED 回流焊后不应该修复，当修复是不可避免时，必须使用双头烙铁，但必须事先确认此种方式会或不会损坏 LED 本身的特性。Repair should not be done after the LEDs have been soldered. When repairing is unavoidable, a double-head soldering iron should be used. It should be confirmed in advance whether the characteristics of LEDs will or will not be damaged by repairing.

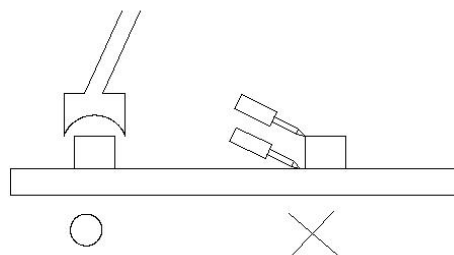

注意事项 Cautions

LED 封装为硅胶，故 LED 胶体表面较软，用力按压胶体表面会影响 LED 可靠性，因此应有预防措施避免在封装的零件上的强大压力。当使用吸嘴时，胶体表面的压力应是恰当的。The encapsulated material of the LEDs is silicone. Therefore the LEDs have a soft surface on the top of package. The pressure to the top surface will be influence to the reliability of the LEDs. Precautions should be taken to avoid the strong pressure on the encapsulated part. So when use the picking up nozzle, the pressure on the silicone resin should be proper.



使用注意事项 Points for attention

1. LED 工作环境及与 LED 适配的材料中硫元素及化合物成分不可超过 100PPM.这只是一个建议，不作任何品质担保.Sulfur and compounds in LED working environment and materials suitable for LED shall not exceed 100 PPM. This is only a recommendation and no quality guarantee is given.
2. 为了防止外界物质进入 LED 内部以造成 LED 的损伤，所处环境及所用套件等等，单一的溴元素含量要求小于 900PPM,单一氯元素含量要求小于 900PPM,溴元素和氯元素总含量必须小于 1500PPM.这只是一个建议，不作任何品质担保.In order to prevent external substances from entering the LED to cause damage to the LED, the environment and the suite used, etc., a single bromine content is required to be less than 900PPM, a single chlorine content is required to be less than 900PPM, and the total bromine and chlorine content must be less than 1500PPM.
3. 应用套件中的挥发物质会渗透到 LED 内部，再通电产生光子以及热的条件下，会导致 LED 变色，进而造成严重的光衰，前提了解套件材料能够避免产生这些问题。群力欣反对使用任何对 LED 器件的性能或者可靠性有害的物质或材料，不管这些材料是已经证实了的还是仅仅怀疑有害。针对特定的用途和使用环境，群力欣建议对所有物质和材料进行相容性的测试。在贴装 LED 的时候，不要使用能产生有机挥发性气体的粘结剂。Volatile substances in the application kit will penetrate into the LED, and then electrify to produce photons and heat conditions, which will lead to discoloration of the LED, resulting in serious light decay. Understanding the kit materials can avoid these problems. Quintly opposes the use of any substance or material harmful to the performance or reliability of LED devices, whether proven or suspected to be harmful. For specific uses and use environments, Quinlixin recommends testing the compatibility of all substances and materials. Do not use LED when you install it.
4. 通过使用适当的工具从材料侧面夹取，不可直接用手或者尖锐金属压胶体表面，它可能会损坏内部电路。By using appropriate tools to clamp from the side of the material, it is not possible to press the colloid surface directly by hand or by sharp metal, which may damage the internal circuit.
5. 设计电路时，通过 LED 的电流不能超过规定的最大值，同时还需要使用保护电阻，否则微小的电压变化将会引起较大的电流变化，可能导致产品损坏。电路设计必须保证只有再开启或者关闭的时候出现正向电压的变化,不要施加反压,否则会损坏 LED.When designing the circuit, the current passing through the LED can not exceed the prescribed maximum value, but also need to use the protective resistance, otherwise small voltage changes will cause large current changes, may lead to product damage. Circuit design must ensure that positive voltage changes occur only when the LED is turned on or off, and no backpressure is applied, otherwise the LED will be damaged.