



苏州群力欣光电科技有限公司

Suzhou Que-lesion Optoelectronic Technology co.,Ltd

产品规格书

SPECIFICATION

客户名称 Customer		产品名称 Product	0603LED
客户料号 Customer No.		产品型号 Type	QSZTYC1-04-5MA
规格书编号 SPEC No	20140318001	日期 Date	2014.03.18

客 户 确 认 APPROVED SIGNATURES		

制定(DRAW): _____ 审核(CHECK): _____ 批准 (APPROVE): _____

地址:江苏省苏州市相城区阳澄湖镇石田路 3 号

ADD:NO.3 shitian road,yangchenhu town,xiangcheng district,Suzhou,china

电话(Tel): 0512-69599058

传真(Fax):0512-65485461



QSZTYC1-04-5MA

特征 Features

- 宽的发光角度
Extremely wide viewing angle
- 适合所有 SMT 组装和焊接过程
Suitable for all SMT assembly and solder process
- 可用在载带及卷轴上
Available on tape and reel
- 防潮等级:3 级
Moisture sensitivity level: Level 3
- 包装:4000pcs/卷
Package:4000pcs/reel
- 符合欧盟 RoHS 标准
RoHS compliant

描述 Description

黄光 LED 由 AlGaInp 四种元素芯片激发而成

The yellow source color devices are made with AlGaInp on Substrate Light Emitting Diode

应用 (Applications)

光学指示

Optical indicator

室内显示

Indoor display

汽车照明

Automotive lighting

LCD 背光、转换器，开关和标志，显示器等 Backlight for LCD , switch and symbol , display

用于日光灯管

Tubular light application

一般应用

General use

QSZTYC1-04-5MA

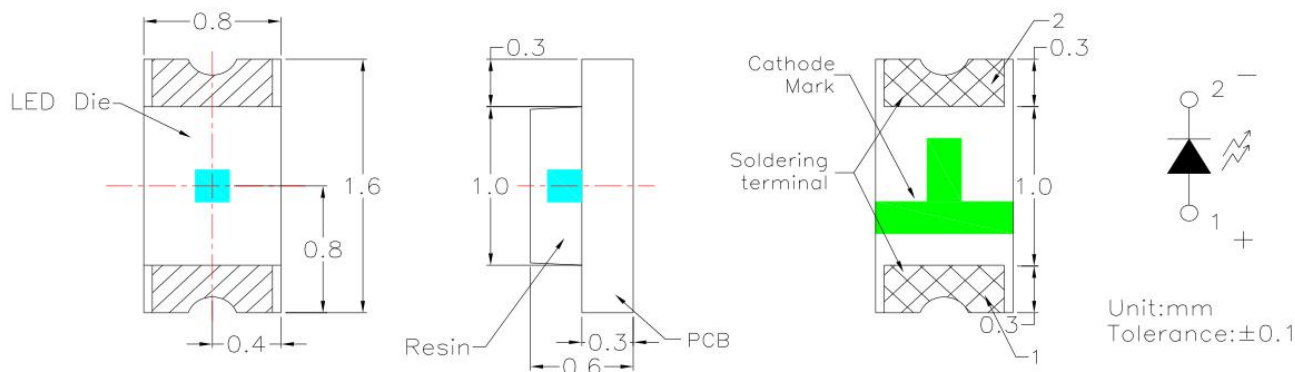

◆ Luminous Intensity BIN Limits

Test condition : @5Ma		
BIN Code	I _{Vmin} (mcd)	I _{Vmax} (mcd)
G1	18	22.5
G2	22.5	28.5
H1	28.5	36
H2	36	45
J1	45	57

◆ Dominant Wavelength BIN Limits

Test condition : @5mA		
BIN Code	λ _{Dmin} (nm)	λ _{Dmax} (nm)
1	582	585
2	585	588
3	588	591
4	591	594

◆ Forward Voltage BIN Limits

Test condition : @5mA		
BIN Code	V _{Fmin} (v)	V _{Fmax} (v)
4	1.8	1.9
5	1.9	2.0
6	2.0	2.1



QSZTYC1-04-5MA

◆ Absolute Maximum Ratings

(Ta=25°C)

Item	Symbol	Maximum	Unit
Power Dissipation	P_D	72	mW
Continuous Forward Current	I_{Fmax}	30	mA
Peak Forward Current (1/10 Duty Cycle 0.1ms Pulse Width)	I_{FP}	100	mA
Reverse Voltage	V_R	5	V
Derating Linear From 25°C		0.4	mA/°C
Operating Temperature Range	Topr	-40 to +85	°C
Storage Temperature Range	Tstg	-40 to +85	°C

◆ Electrical / Optical Characteristics

(Ta=25°C)

Item	Symbol	Condition	Min.	Typ.	Max.	Unit
Forward Voltage	V_F	$I_F=5mA$	1.8	2.0	2.1	V
		$I_F=20mA$		2.1	2.4	
Reverse Current	I_R	$V_R=5V$			10	uA
Peak Emission Wavelength	λ_p	$I_F=20mA$		595		nm
Dominant Wavelength	λ_D	$I_F=5mA$	582	588	594	nm
		$I_F=20mA$	585	591	596	
Viewing Angle	201/2	$I_F=20mA$		130		Deg
Luminous Intensity	I_V	$I_F=5mA$	18.0	28.5		mcd
		$I_F=20mA$	45.0	72.0		

※The measuring tolerance → Luminous intensity ±15%

Wavelength (λ_D) ±2nm

QSZTYC1-04-5MA

Forward Current Vs. Forward Voltage

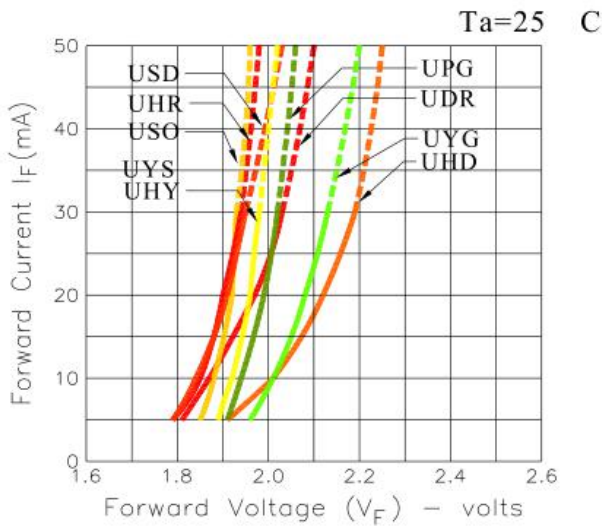

Luminous Intensity Vs. Forward Current

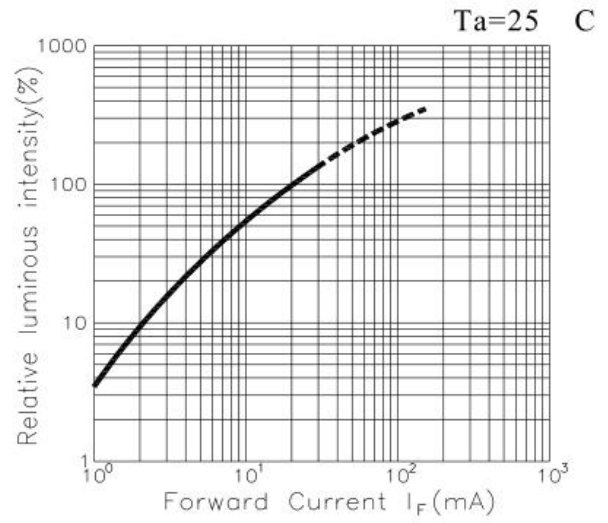

Forward Current Derating Curve

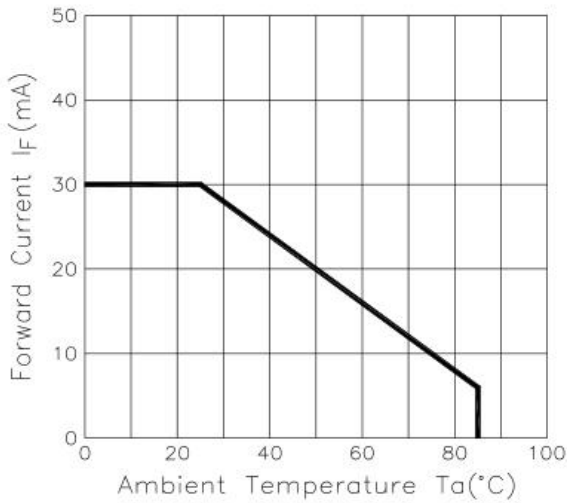

Radiation Diagram

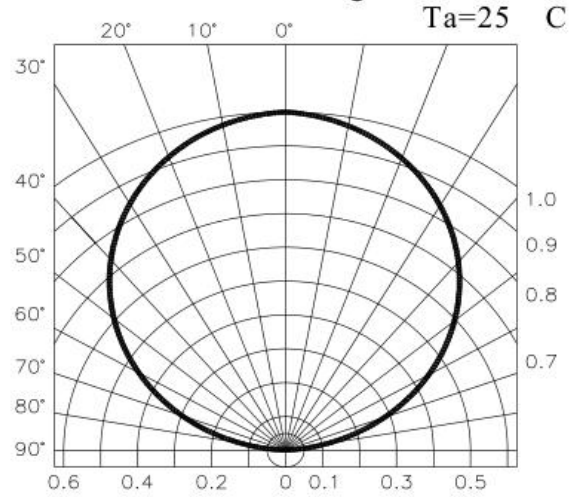

Spectrum Distribution

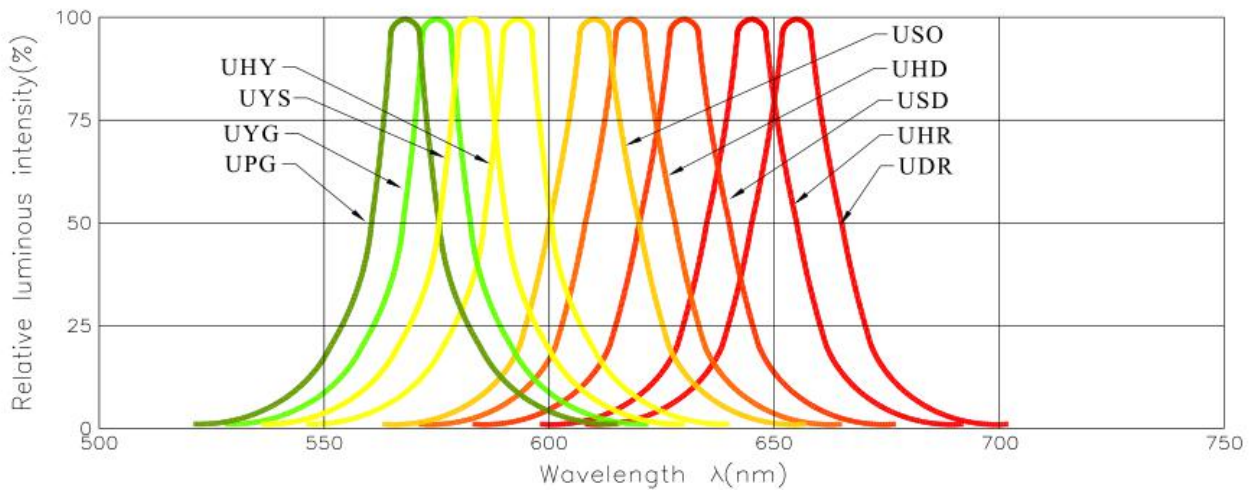

QSZTYC1-04-5MA

◆ Reliability Test Items And Conditions :

No.	Item	Test Conditions	Test hr/cycle/time	Sample Q'ty	Ac / Re
1	Solder Heat	TEMP : 260°C ± 5°C ; 10 ± 1 sec	2 times	30 pcs	0 / 1
2	Solderbility Test ※	TEMP : 235°C ± 5°C ; 3 ± 1 sec	1 time	5 pcs	0 / 1
3	Temperature Cycle	H : +85°C 30min. ∫ 5min. L : -40°C 30min.	100 cycles	20 pcs	0 / 1
4	Thermal Shock	H : +85°C 5min. ∫ L : -40°C 5min.	50 cycles	20 pcs	0 / 1
5	High Temperature Storage	TEMP : 85°C	1000 hrs	20 pcs	0 / 1
6	Low Temperature Storage	TEMP : -40°C	1000 hrs	20 pcs	0 / 1
7	DC Operating Life	$I_F = I_{Fmax}$	1000 hrs	20 pcs	0 / 1
8	High Temperature High Humidity	85°C / 90~95%R.H.	1000 hrs	20 pcs	0 / 1
9	Shocking test	100~2000Hz ; 98.1m/s ² X,Y,Z direction	2 hrs	20 pcs	0 / 1
10	Dropping test	Put on pallet ; height : 75cm	3 times	20 pcs	0 / 1
Judgment Criteria					
Forward Voltage V_F		V_F Max-Increase < 1.1x			
Reverse Current I_R		I_R Max-Increase < I_{Rmax}			
Luminous Intensity I_V		I_V Decay < 40%			
※Solderbility test criteria : coverage is not less than 95%					
Note : Measurement shall be taken after the tested samples have been returned to normal ambient conditions (generally after two hours)					

◆ Test Circuit

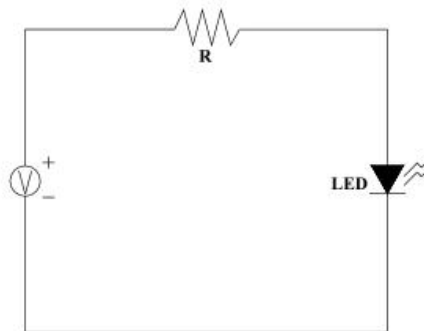

QSZTYC1-04-5MA

包装 Packaging

标签 Label

料号 Part No.:*** 批号 Lot No.:*** 数量 O'ty(pcs):***
 亮度 Iv(mcd):*** 波长 (nm) :*** 电压 VF (v) :***
 日期 Date:***

载带规格 (单位: mm) Tape Specifications(Units:mm)

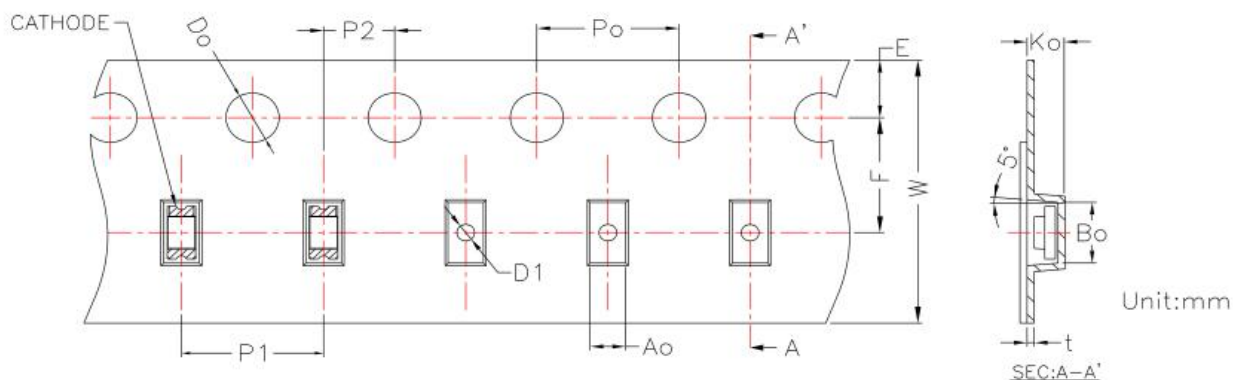

卷轴尺寸 Reel Dimensions

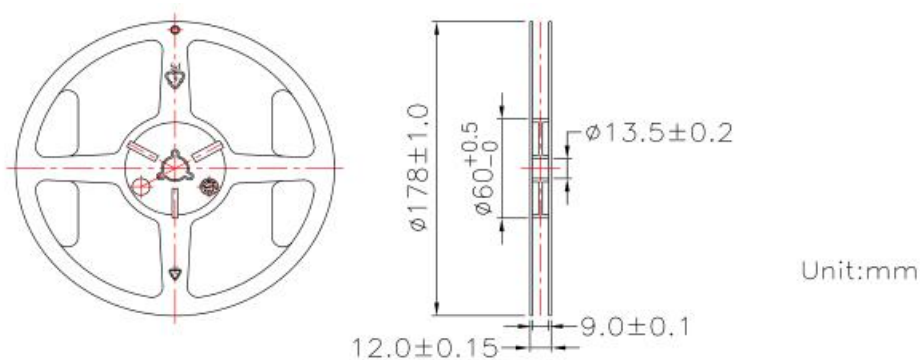

防潮袋包装 Moisture Resistant Packaging

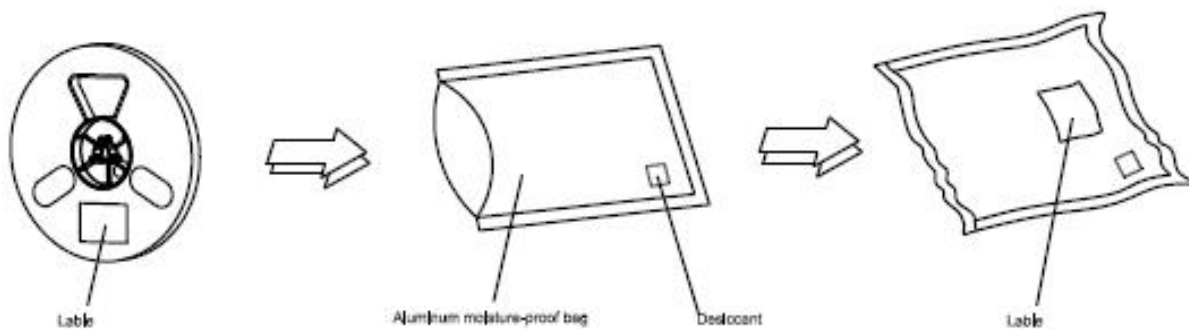

备注: 标注公差为 ± 0.1 mm,单位: mm

Note : The tolerances unless mentioned is ± 0.1 mm,Unit:mm

QSZTYC1-04-5MA

焊接指导 Guideline for Soldering

Soldering iron 烙铁焊接

1. When hand soldering, keep the temperature of iron below less 300°C less than 3 seconds

当手工焊接时，烙铁的温度必须小于300℃，时间不可超过3秒

2. The hand solder should be done only one times

手工焊接只可焊接一次

Repairing 修补

Repair should not be done after the LEDs have been soldered. When repairing is unavoidable, a double-head soldering iron should be used (as below figure). It should be confirmed in advance whether the characteristics of LEDs will or will not be damaged by repairing.

LED回流焊后不应该修复，当修复是不可避免时，必须使用双头烙铁（如下图），但必须事先确认此种方式会或不会损坏LED本身的特性。

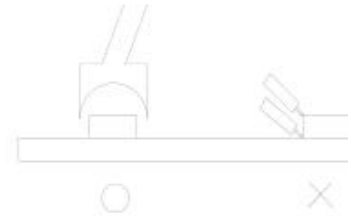
**Cautions 注意事项**

The encapsulated material of the LEDs is silicone. Therefore the LEDs have a soft surface on the top of package. The pressure to the top surface will be influence to the reliability of the LEDs. Precautions should be taken to avoid the strong pressure on the encapsulated part. So when use the picking up nozzle, the pressure on the silicone resin should be proper.

LED封装为硅胶，故LED胶体表面较软，用力按压胶体表面会影响LED可靠性，因此应有预防措施避免在封装的零件上的强大压力，当使用吸嘴时，胶体表面的压力应是恰当的。

3. Do not stack together assembled PCBs containing LEDs. Impact may scratch the silicone lens or damage the internal circuitry

不可将模组材料堆积在一起，它可能会损坏内部电路

4. Not suitable to operate in acidic environment, PH<7

不可用在PH<7的酸性场所

